

# INSTRUCTION MANUAL

# IRRI-TAPE™

*The space-age bird repellent ribbon from*

*The Bird Control "X-perts"*



BIRD-X Inc. is the world's leading bird control specialist and supplier of unique, effective and ecologically safe bird repelling products. We have utilized the latest in Space Age technology and materials to develop IRRI-TAPE.

IRRI-TAPE is an iridescent diffraction foil that dramatically affects birds' vision, hearing and feeling. By combining holography, wind and light it creates an "off limits" zone which deters pest birds.

IRRI-TAPE is made of 2-mil polyester ribbon imprinted with a holographic pattern of interlocking circles. This pattern resembles the eyes of owls, who are the natural predators of many birds. This three - dimensional image medium reflects all of the colors of the spectrum with laser-like intensity.

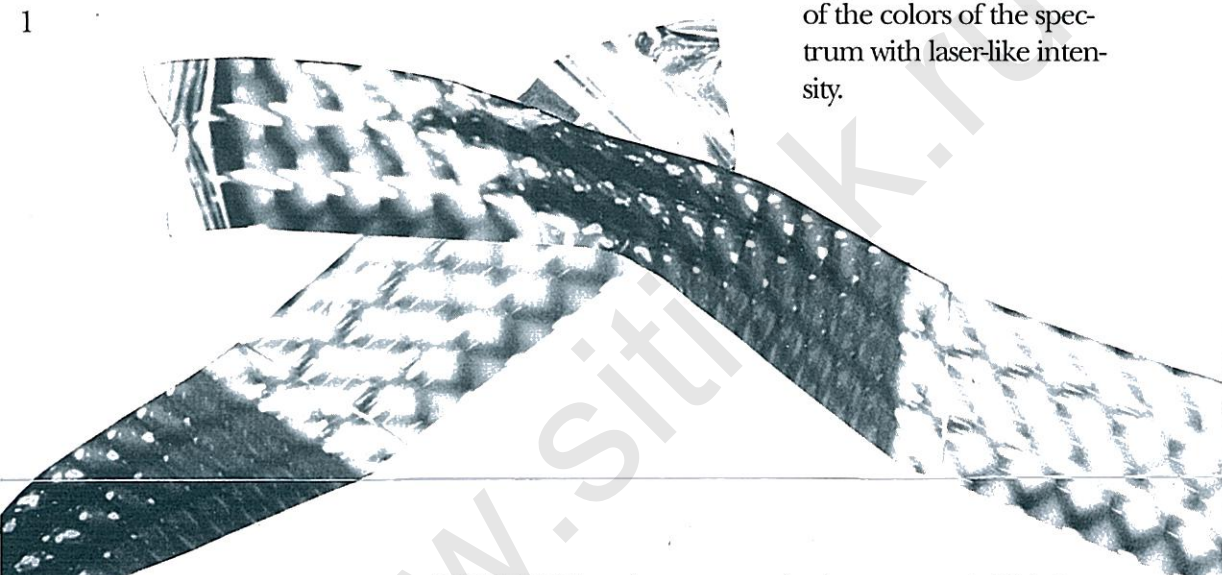

**IRRI-TAPE's unique properties keep unwanted birds away by playing several different roles:**

**IT IS A VISUAL DETERRENT:** the light reflected from its surface is perceived in a "ripple" pattern that is both three dimensional and highly chromatic. Both features represent a menace to pest birds.

**IT IS A HOSTILE SOUND ENVIRONMENT:** wind (even the slightest breeze) will produce a fierce metallic-sounding "rattle" which is unsettling to the infesting birds, and...

**IT IS A PHYSICAL BARRIER:** when applied in a linear fashion – along a ledge, fence, etc. – it cuts off access to birds' "landing strips".

1

2

## A WORD ABOUT HOLOGRAPHY

In its most basic definition, a hologram is a device that has been created with a laser. Microscopic structures in the material cause reflected light to be re-formed into three-dimensional images.

While a photograph is flat (confined to the surface) a holographic image has depth and appears to float in space.

A holograph also has the unique ability to "change color" as it moves. It is actually reflecting the full spectrum of color that exists in nature, but different colors are seen from different angles.

IRRI-TAPE simply uses these holograms that have been transferred to the extremely thin polyester ribbon in a permanent bond. The images will never wear off of the ribbon. They won't fade, peel or lose their impact...ever.

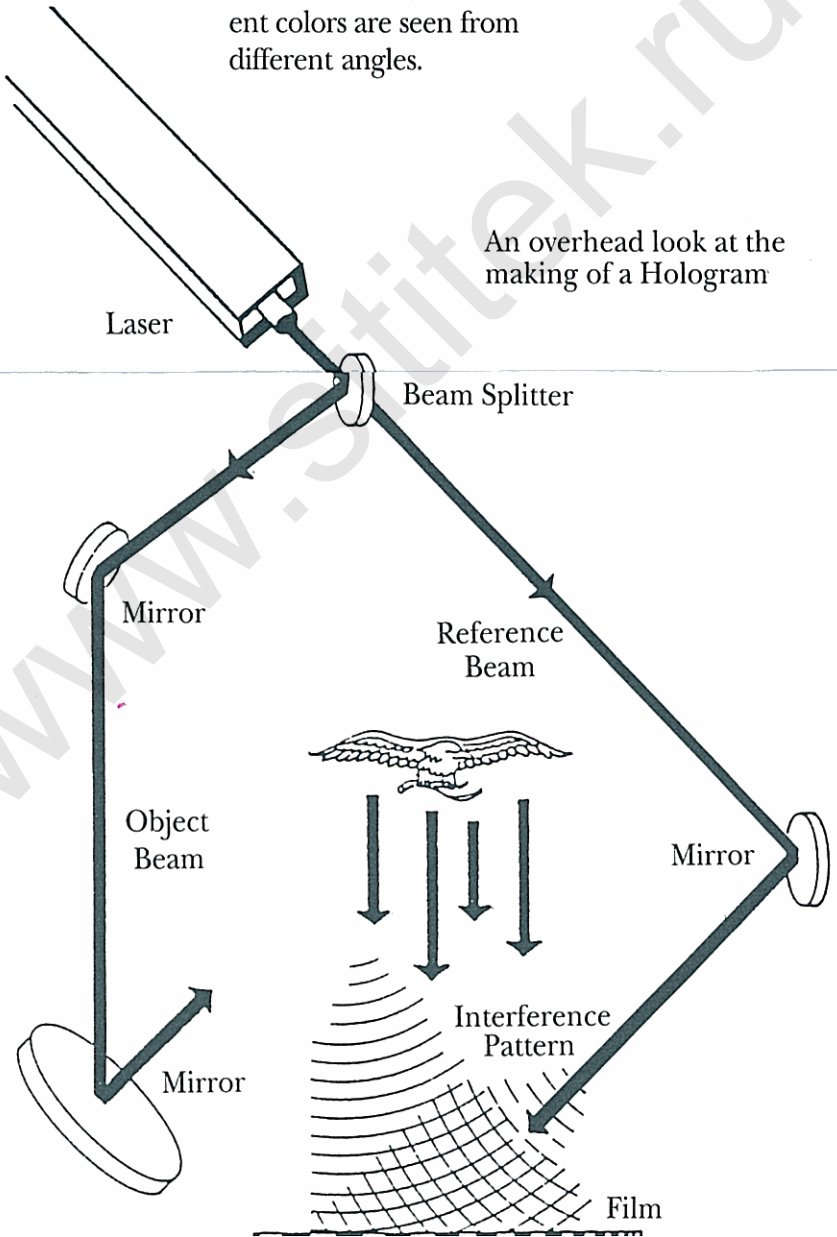

3

4

## PREPARATION OF APPLICATION AREA

A. Remove any foliage from above the IRRI-TAPE application area so that twigs, leaves, etc. will not drop on it.

5 B. Remove all bird excreta, dirt, debris, flaking paint, grease, etc., from application area.

CAUTION: if bird droppings are unusually heavy, wear a protective (respiratory) face mask and protective (disposable) gloves before handling.

## BASIC INSTALLATION

Regardless of the surface you intend to protect, study the actual area closely for clues to the optimum deployment pattern of the material. (Example: if you are able to determine that the pest birds typically approach the infested area from the same direction you will know where to begin your installation.)

**LINEAR APPLICATION:** Plot the line you wish to protect and position the support brackets at intervals of 12' to 15' along that line.

Once the brackets are mounted (see Bracket Mounting Instructions on p. 9) unroll the reel of IRRI-TAPE and thread it through the support brackets along their entire length. Simply slide the tape through the minute gap at the base of the inverted triangle that forms the top of the bracket. When properly positioned the ribbon should run inside the very top of the bracket on a horizontal plane parallel to the ground.

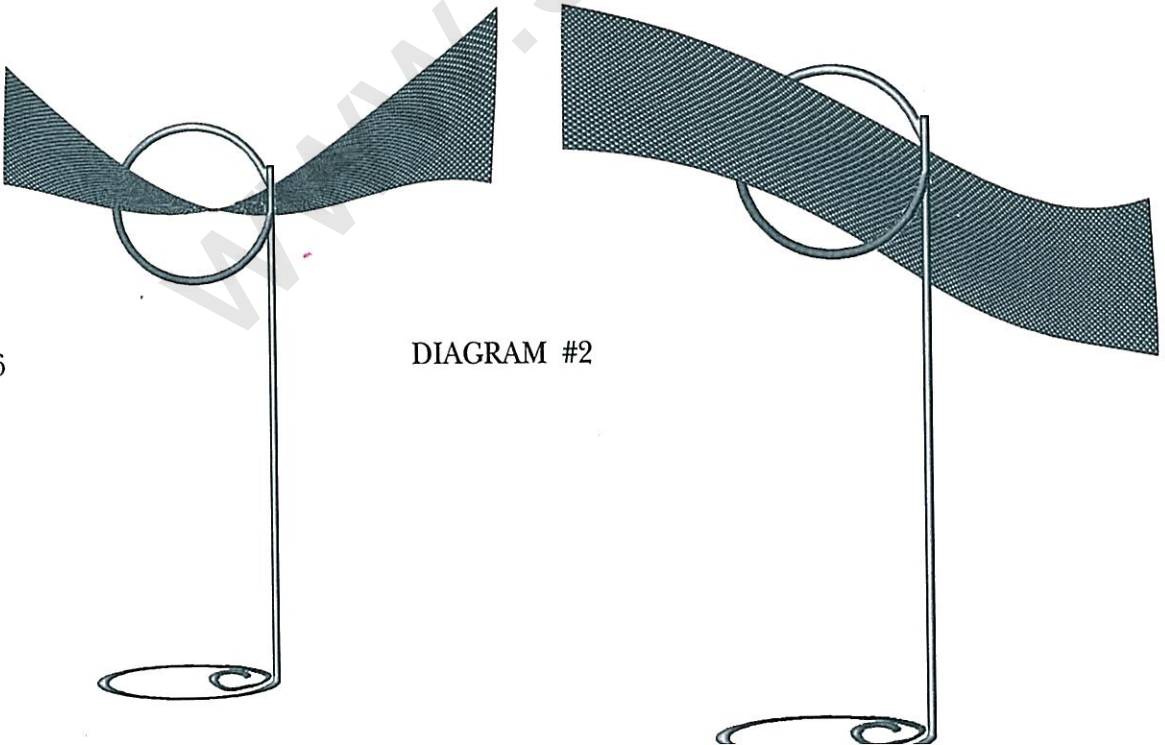
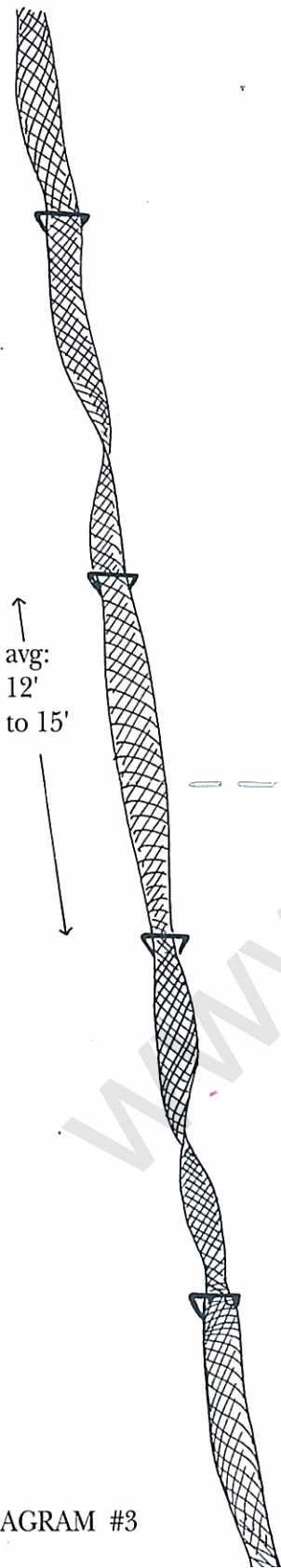

DIAGRAM #2



For maximum effectiveness, invert (twist to form a spiral) at least once between each pair of brackets. Always leave enough slack to allow free movement in the breeze. Do not pull ribbon too tight. Finally, tie off or clamp ends securely.

**THE MAYPOLE:** Use a strong pole, 2 x 2 fencepost or any other suitable vertical upright as your support. Gather 12 or more lengths of IRRI-TAPE that are 1/2 to 2/3 of the height of the support and attach them to the top. This is excellent near shrubbery, small trees and on boats.

**THE WRAP:** For orchards, especially free standing fruit trees which are particularly vulnerable to bird "attack", wrap the tree by spiralling IRRI-TAPE around it from bottom to top.

**STREAMERS:** You can multiply the effectiveness of IRRI-TAPE by attaching cross strips to main "runner" or attaching to branches to supplement "The Wrap". Cut lengths of 2 to 3 feet and simply tie them on at regular intervals.

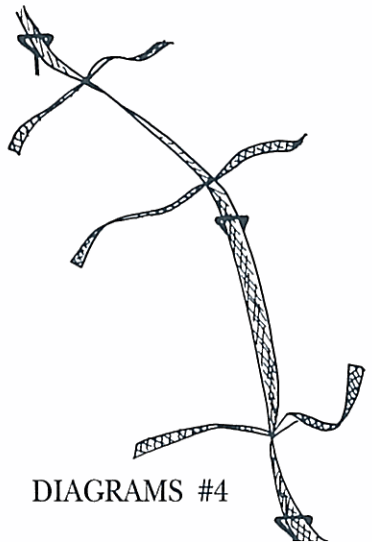
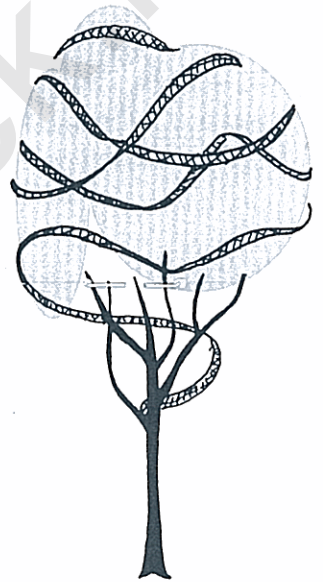
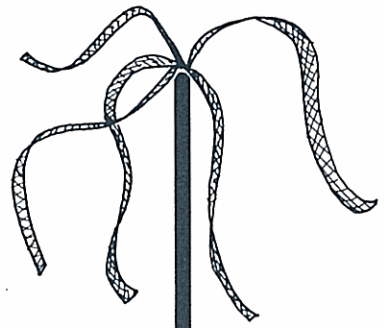

DIAGRAM #3

DIAGRAMS #4

## BRACKET MOUNTING

In the base of each bracket is a 1/4" hole.

Whatever mounting hardware is used, make sure that the diameter of its head exceeds 1/4".

### MASONRY

(stone, concrete, terra cotta, brick, etc.): Drill 5/16" holes at least 1" deep. Insert nylon anchors. Position bracket base over hole and drive spiral stainless steel nails flush with hammer.

WOOD: Use any sturdy nails or wood screws and drive them flush with a hammer or screwdriver.

SHEET METAL: Create small holes with a drill punch or nail, then mount with sheet metal screws and screwdriver.

SIGNS, CABLES, RAILINGS, PIPING or TUBING: With plastic strap ties or stainless steel wire ties (and a wire tightening tool) simply "wrap" the base to the mounting surface, then tighten down with the twisting (tying) tool.

ANY MOUNTING SURFACE REQUIRING ADHESIVE: Apply a bead of Eclectic 6000 Structural Adhesive to both the bottom of each bracket and the mounting surface. Slide surfaces together and allow 24 hours for setting.

GROUND (soil): Use any long nail, rivet, rod or dowel to act as an anchoring stake and drive it into the ground with a hammer or mallet.

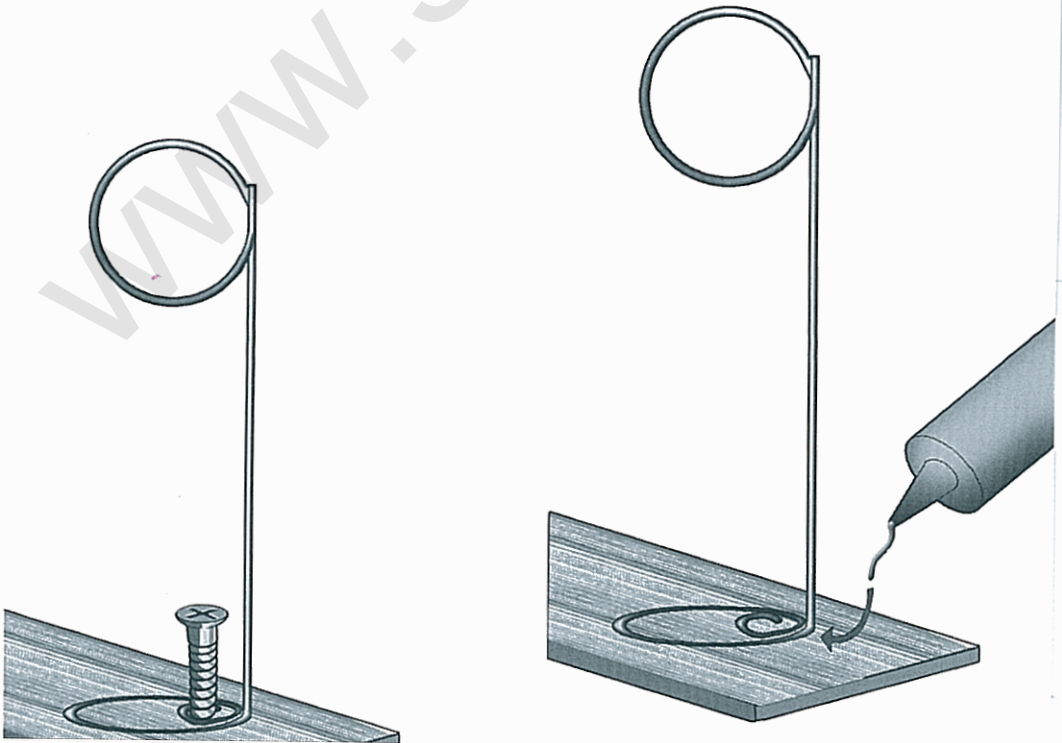

## TYPICAL APPLICATIONS

### GROUND ROW CROPS:

Secure IRRI-TAPE from stakes, posts or irrigation risers every 12 to 15 feet down the row. Place IRRI-TAPE just above the crop being protected. Place on every row. On high density large and bushy crops such as blueberries, grapes, etc., where overhead placement is difficult, run ribbon strips down both sides of each row and tie it to outer upper branches. On smaller plantings suspend IRRI-TAPE above the entire area on 6' to 8' tall poles spaced to form 8' to 10' wide rows.

### SPECIFIC CROPS:

**Strawberries** - Place two stakes at ends of bed about 2' above ground level.

**Raspberries** - Fasten to existing "training" stakes.

**Free standing fruit trees** - Use the "wrap" (p.8)

**PARKING LOTS:** Similar row type coverage as used for open agricultural crop land - with the exception that ribbon can also utilize light stanchions or other existing poles for attachment.

### MARINE APPLICATIONS:

(Against seagulls, etc.)

**Yachts** - Secure ribbon to forestay approximately 3' above deck. Suspend line taut to shrouds and backstay.

**Power craft** - Secure at any convenient locations.

### PONDS AND LAWN:

(Protect from ducks, geese, etc.) Run ribbon 4' to 6' above ground as is convenient tied to stakes or other supports. Streamers (see diagrams 4 on p. 8) are effective in this application.

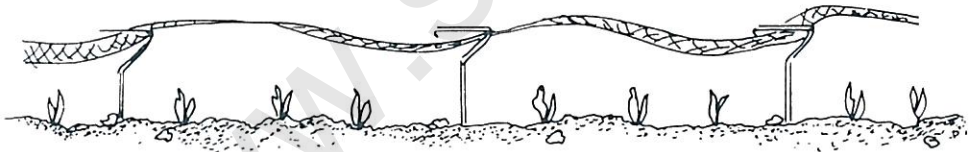

ground crops

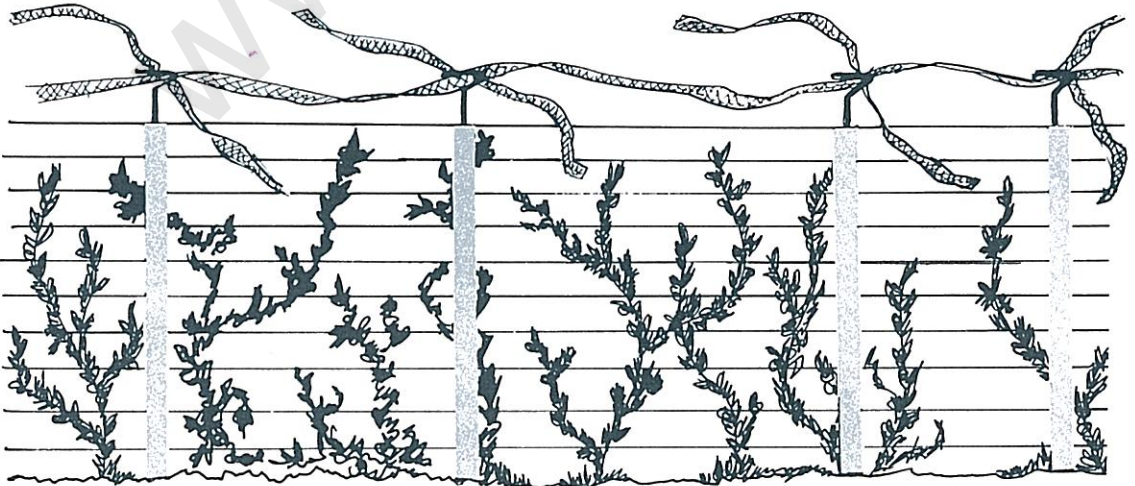

vines and arbors

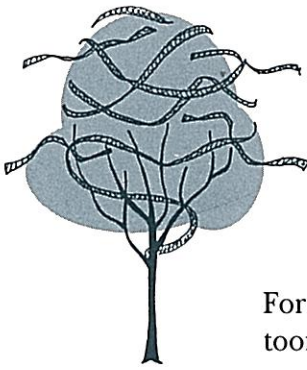

For trees - "wrap" or "fes-  
toon" as needed

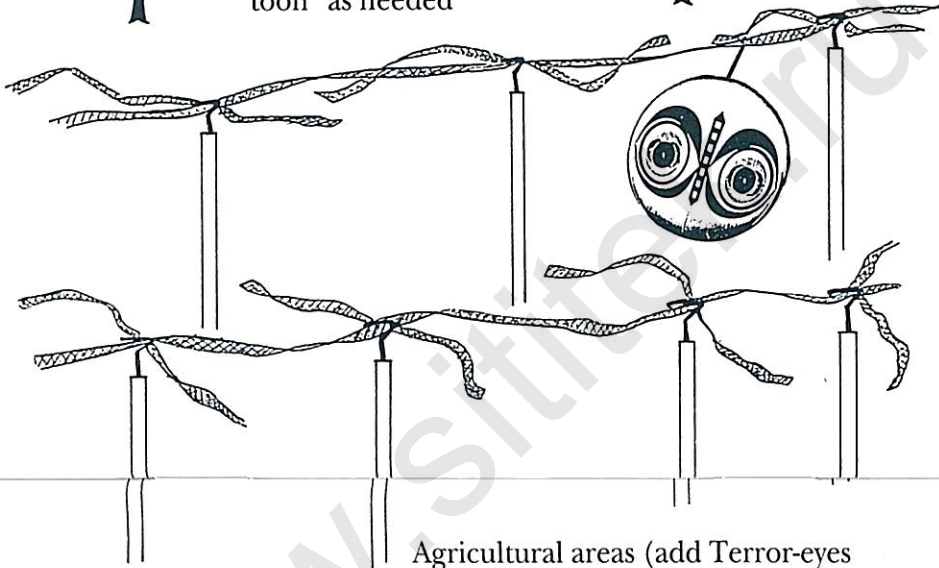

Agricultural areas (add Terror-eyes  
to increase the "scare" effect)

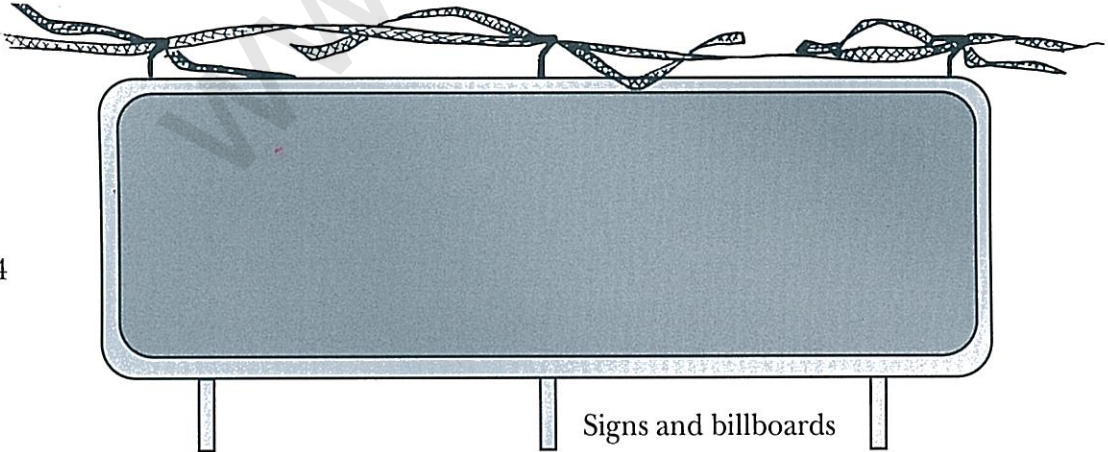

Signs and billboards

Application possibilities are limitless.

IPBLTAP® will work almost any way that you choose to apply it



In this package you will find:

In Kit #TAPE-100

100 ft of IRRI-TAPE

8 BRACKETS

INSTRUCTION MANUAL

In kit #TAPE-500

500 ft of IRRI-TAPE

36 BRACKETS

INSTRUCTION MANUAL

*The Bird Control "X-perts"*

**BIRD-X** INC



300 North Oakley Boulevard

Chicago, Illinois 60612

USA